

Product User Manual



Digital Inverter Gas-shielded Welding Machine

MIG-135A/140A/160A/165A/180A/200A/250A



Model:

Model code:













Content

01	Safety	1 Safety instruction----- P ₀₁
02	General Description	2 Characteristics of digital Inverter gas-shielded welding machine-----P ₀₂
03	Circuit Diagram	3 Schematic diagram of main circuit-----P ₀₃
04	Main Paramete	4 Basic parameters----- P ₀₃
05	Panel Structure	5-1 Front panel structure-----P ₀₄ 5-2 Back panel structure-----P ₀₅ 5-3 Front panel structure of digital screen-- P ₀₅
06	Installation & Operation	6-1 Connection of input cable-----P ₀₆ 6-2 Installation of MMA welding-----P ₀₆ 6-3 Installation of gas shielded arc welding---P ₀₇ 6-4 Installation of gas shielded arc welding---P ₀₈ 6-5 Installation of gas shielded arc welding---P ₀₉
07	Caution	7-1 WorkingEnvironment-----P ₁₀
08	Maintenance	8 Maintenance of welding machine-----P ₁₁
09	Troubleshooti	9 Common Malfunction Analysis and Solutiont P ₁₁

1 Safety instruction

As the user's manual of digital MIG series inverter welding machine, this Manual is only for the MIG series welder. No prior notice will be given in case of any change.

In the benefit of you and others, we recommend you to read and fully understand this Manual before installation and operation.

 Note	<p>Please install and use strictly according to the Manual!</p> <p>Electrical connection can be done only after the power of the distribution box is turned off. The operation process shall conform to relevant safety operation rules.</p>		
	<p> Warning</p> <p>An electric shock may hurt or even kill people.</p>	<p>Please turn off the power of the distribution box before wiring. Do not touch exposed conductive parts.</p>	 <p>Welding operation may cause fire or explosion!</p> <p>Welding spatter may ignite combustibles nearby. Combustibles shall be placed at least 10m from the welding site. Prevent the spatter from falling on clothes or body.</p>
	<p>The welding fume is harmful to health. Do not inhale the fume produced during welding. Clean up the greasy dirt on work piece. Keep the welding site in ventilation. Smoke and dust exhausting facility shall be arranged at the welding station.</p>		 <p>The arc light may hurt the eyes and the skin. Strong arc light may hurt the eyes. The ultraviolet rays produced by the electric arc may hurt the skin and the eyes, and please wear labor protection clothes properly during welding.</p>
	<p>Inert gases are harmful to the human body. Inert gases are harmful to the human body and even cause suffocation, so please choose a well-ventilated environment for welding. If not, please close the gas cylinder valve.</p>		 <p>High-frequency arc ignition may cause electromagnetic radiation. Radiation may interfere with other devices! Contact arc ignition can be used to avoid interference.</p>
	<p>The overheated part may burn the skin, and do not touch the overheated welding part. The overheated part may burn the skin, and do not touch the overheated welding part.</p>		 <p>High-speed moving objects may cause hurt. and do not put your hands or a thin objects into the fan hood. Please cover the open shell during welding.</p>
	<p>The gas cylinder may explode. so do not to heat it. It is preferred to keep the gas cylinder away from the welding site and fix it well.</p>		 <p>Personal protection. To prevent eye and skin injury, please comply with the rules of labor safety and health and wear necessary protective clothing!</p>

GENERAL DESCRIPTION**2 Characteristics of digital Inverter gas-shielded welding machine**

Thank you for buying the digital inverter welding machine . Please read the Manual carefully before use.

The performance features are as follows:

- Use full-digital control system to realize precise control and stable arc length during welding. Use full-digital wire feeding control system to realize precise and stable wire feeding.
- Friendly operation interface, unified regulating mode, easy to master.
- Gas shielded arc welding, MMA welding and Self Shielded arc welding are available.
- IGBT technology and unique control enhance the reliability of the welding machine.
- High duty cycle, long time welding is available.
- Closed loop feedback control, constant voltage output, workable under network voltage fluctuation within $\pm 15\%$.
- Adjustable welding voltage and circuit, excellent welding characteristics.
- Unique dynamic characteristic control circuit is used in gas shielded arc welding, stable arc, little splash, good shaping, efficient welding.
- Melting ball removing, high no-load and slow wire feeding function increase the success rate of arc starting.
- Stable current and excellent arc starting in MMA welding, and various welding rods can be used.
- Inverter frequency is 35 KHz, greatly reducing the volume and weight of the welder.
- Great reduction in metal loss obviously enhances the welding efficiency and energy saving effect.
- Switching frequency is beyond audiorange, which almost eliminates noise pollution.

03

CIRCUIT DIAGRAM

3 Schematic diagram of main circuit

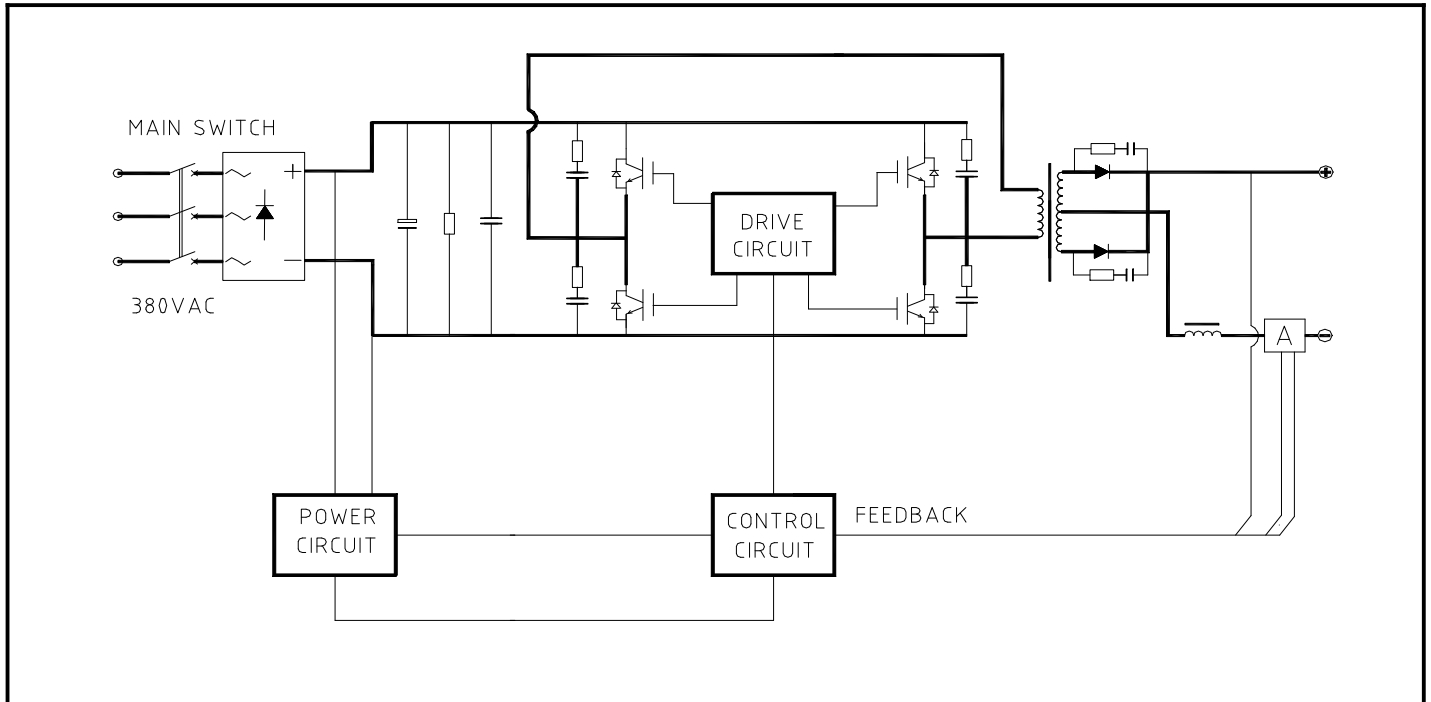

04

MAIN PARAMETER

4 Basic parameters

TYPE	MIG135A	MIG140A	MIG160A MIG165A	MIG180A	MIG200A MIG250A
Input power voltage (V)	Single-phase AC110/220V±15%, 50/60Hz				
Rated input current (A)	26/52	27/52	32/54	37/64	43/75
Rated power capacity(KVA)	5.7	6.0	7.0	8.2	9.4
Recommended fuse capacity(A)	40/63	40/63	40/63	40/80	63/80
Current adjustment range (A) (MMA welding)	20~135	20~140	20~160	20~180	20~200
Current adjustment range (A) (Gas shielded arc welding)	25~135	25~140	25~160	25~180	25~200
Voltage adjustment range (V) (Gas shielded arc welding)	11~24	11~26	11~27	11~27	11~28

No-load voltage (V)	50	59	59	59	59
Feeding speed adjustment range (m/min)	1.5~16	1.5~16	1.5~16	1.5~16	1.5~16
Welding wire diameter (mm)	0.6/0.8	0.6/0.8	0.6/0.8/1.0	0.6/0.8 /1.0	0.6/0.8/1.0
Rated duty cycle	35% 40°C				
Efficiency (%)	85	85	85	85	85
Power factor	0.7	0.7	0.7	0.7	0.7
Protection class	IP21S				
Insulation class	F				
Size (mm)	450*255*380	515*275*465	515*275*465	515*275*465	515*275*465
Weight (Kg)	16	20	20	24	25

05

MAIN PARAMETER

5.1 Front panel structure

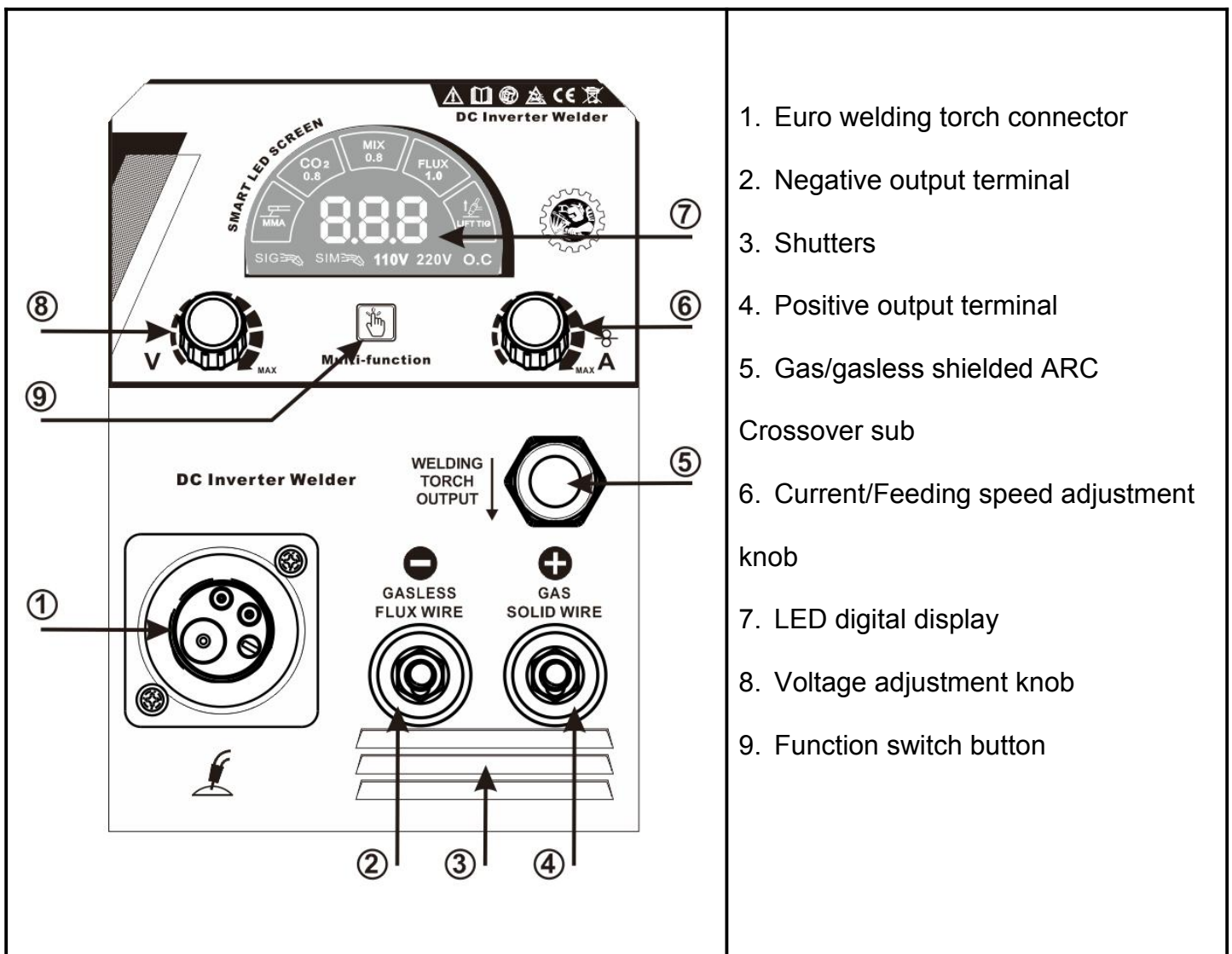

5.2 Back panel structure

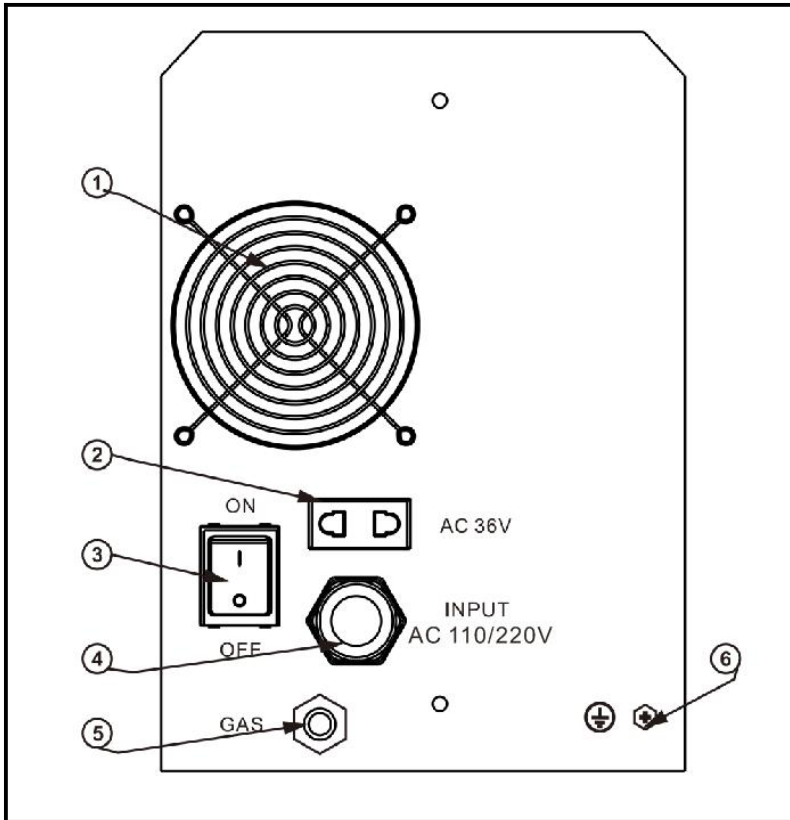

1. Fan
2. Pressure reducing valve power supply (ac-36v)
3. Power switch
4. Input power cable
5. GAS IN
6. Grounding screw

5.3 Front panel structure of digital screen

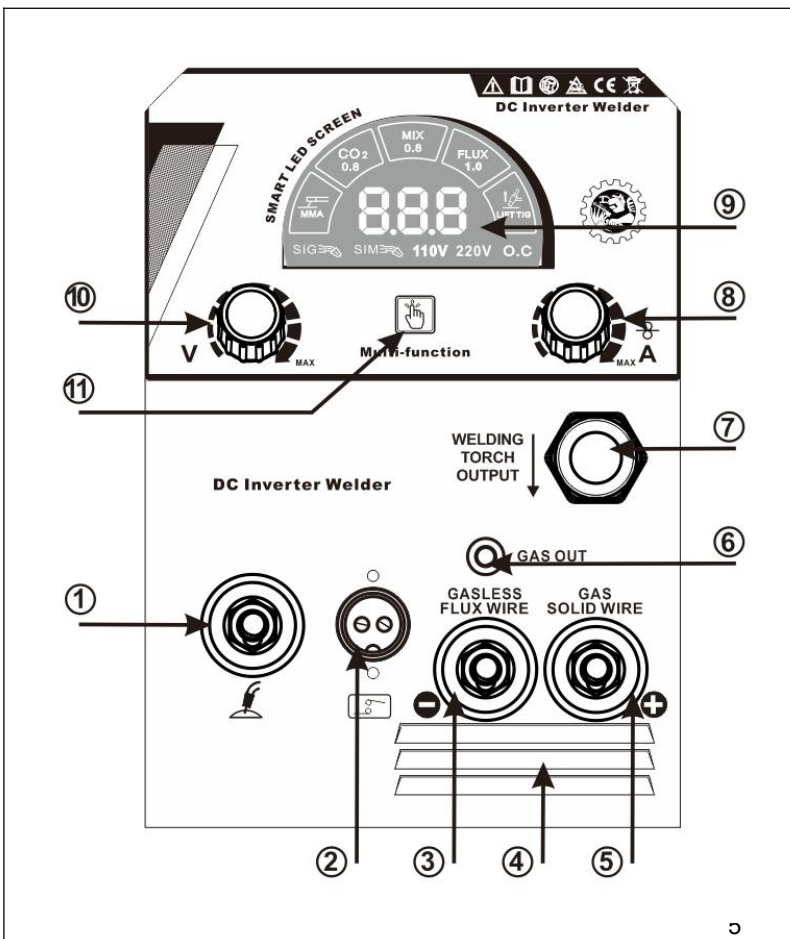

1. 10-25 welding torch connector
2. Welding gun switch
3. Negative output terminal
4. Shutters
5. Positive output terminal
6. Gas out
7. Gas/gasless shielded ARC Crossover sub
8. Current/Feeding speed adjustment knob
9. LED digital display
10. Voltage adjustment knob
11. Function switch button

06

INSTALLATION & OPERATION

Note: Please install the machine strictly according to the following steps.

- Electric connection operation should be after turning off the power supply switch of the switch box.
- The protection class of this machine is IP21S, so avoid using it in rain.

6.1 Connection of input cable

- (1) A primary power supply cable is available for this welding machine. Connect the power supply Cable with required voltage. (Note: Earth the machine reliably during connection.)
- (2) The primary wire should be connected to the corresponding socket to avoid oxidization.
- (3) Use multi-meter to see whether the voltage value varies within the given range.

6.2.1 Installation of MMA welding

- (1) Two air sockets are available for this welding equipment. Connect the plug to the socket on the panel board. It is possibly damaging to both the plug and socket, if the plug and the socket are incorrectly connected.
- (2) The electrode holder cable should be connected to the negative terminal, while the work piece should be connected to the positive terminal.
- (3) Serious attention should be paid to the electrode of the wire. Generally, two modes of connection of DC welding equipment are available:
 - Positive connection: electrode holder to “-”, while work piece to “+”;
 - Negative connection: work piece to “-”, while electrode holder to “+”.Opt the mode according to practical requirements, and incorrect connection may cause unstable arc, splash and conglutination of rod and work piece etc.
- (4) In case that minimum distance between work piece and this welding equipment is over 50m, as a consequence it spells the over-length of the secondary cable including electrode holder cable and earth cable. Therefore it is necessary to increase the diameter of cable In order to maintain and improve the performance of voltage output.

6.2.2 Installation sketch map

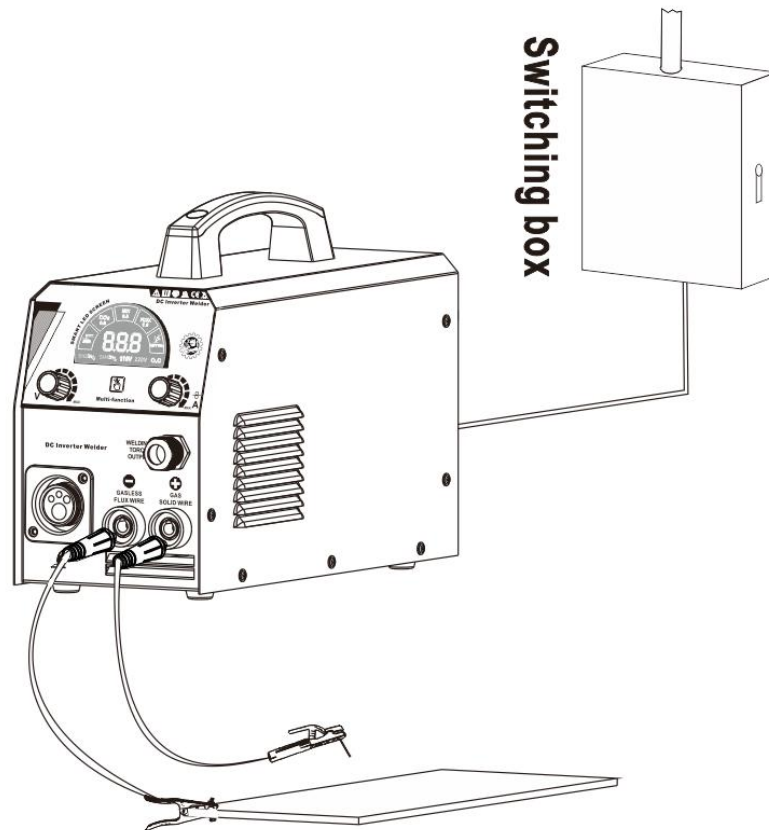

6.2.3 Operation

- (1) Turn the power switch on the back panel to “ON” position after the installation according to the above steps, the machine is started, the power LED turns on, and the fan works.
- (2) Turn the conversion switch on the front panel to “MMA” position, and adjust the welding current adjustment knob according to the workpiece thickness to get the desired welding performance.
- (3) Generally, the required welding current is listed as follows:
 $\Phi 2.5$: 70-100A; $\Phi 3.2$: 110-160A; $\Phi 4.0$: 170-220A; $\Phi 5.0$: 230-280A

6.3.1 Installation of gas shielded arc welding

- (1) Plug the welding torch into the output socket “” on the front panel, and tighten it. Thread the wire into the torch manually.
- (2) Insert the earth cable plug into the negative socket on the front panel, and tighten it clockwise.
- (3) Insert the adapter plug into the positive socket on the front panel, and tighten it clockwise.
- (4) Fix the welding wire coil to the rack axis on the wire feeder; make sure the hole of the wire feeding wheel matches well with the bolt on the rack axis and the welding wire diameter. Unfasten the screw on the wire-pressing wheel, and make the wire into the groove of the wire feed wheel, press the wire tightly, but not too tight, and then thread the wire into the torch. Press the torch switch to send out the wire Welding gun.

- (5) Tightly connect the gas hose, which come from the back of the machine to the copper nozzle of gas bottle.

6.3.2 Installation sketch map

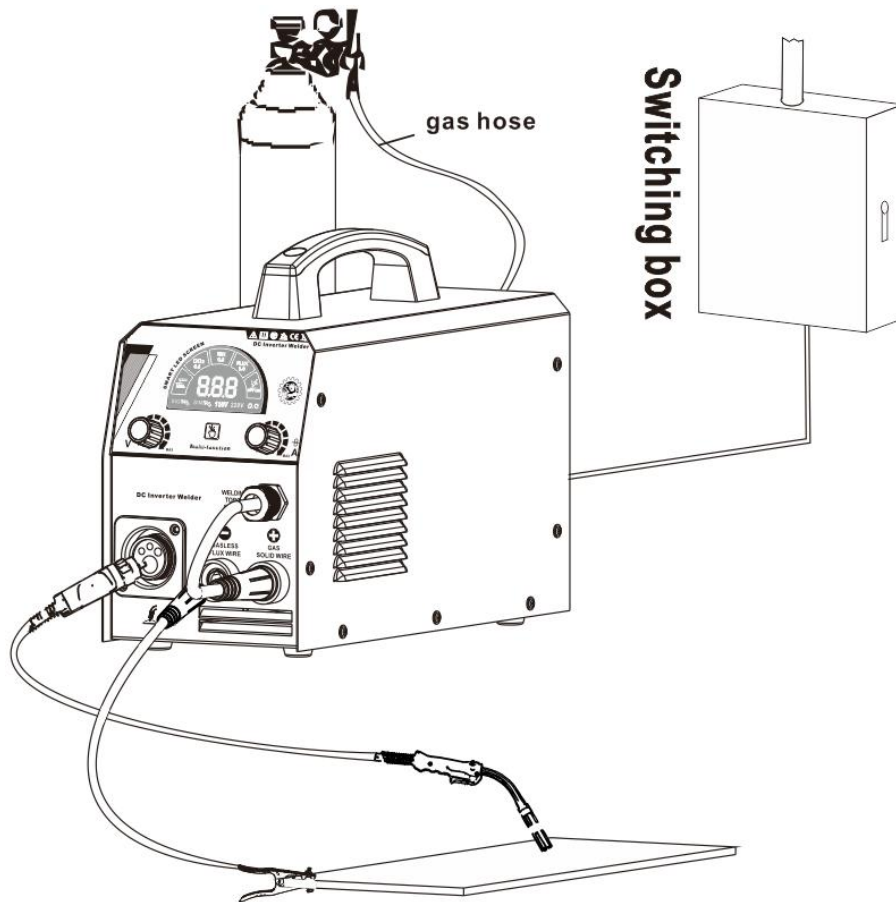

6.3.3 Operation

- (1) After installation according to the above steps, turn the power switch on the back panel to "ON" position, then the power LED turns on, and the fan works. Open the gas cylinder valve, and adjust the flow meter to the desired position.
- (2) Press the function conversion button on the front panel to convert the function to "CO₂" or "MAG"
- (3) adjust the welding voltage adjustment knob and wire feeding speed adjustment knob according to practical needs to get the desired welding voltage and welding current.
- (4) Press the welding torch switch, and welding can be carried out.
- (5) Cut off the gas 1s after the arc is stopped.

6.4.1 Installation of self shielded arc welding

- (1) Plug the welding torch into the output socket "🔧" on the front panel, and tighten it. Thread the wire into the torch manually.
- (2) Insert the earth cable plug into the positive socket on the front panel, and tighten it clockwise.
- (3) Insert the adapter plug into the negative socket on the front panel, and tighten it clockwise.

- (4) Fix the welding wire coil to the rack axis on the wire feeder; make sure the hole of the wire feeding wheel matches well with the bolt on the rack axis and the welding wire diameter. Unfasten the screw on the wire-pressing wheel, and make the wire into the groove of the wire feed wheel, press the wire tightly, but not too tight, and then thread the wire into the torch. Press the "wire feeding" button to feed the wire out of the welding gun.

6.4.2 Installation sketch map

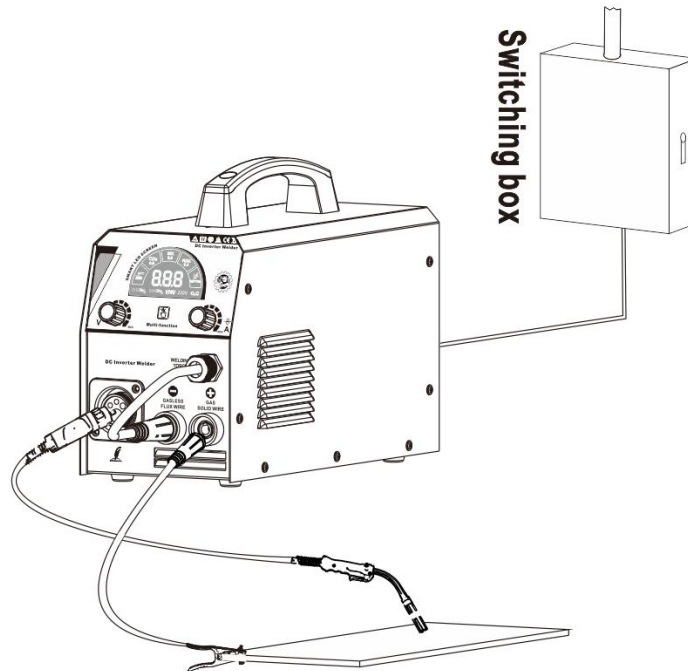

6.4.3 Operation

- (1) After installation according to the above steps, turn the power switch on the back panel to "ON" position, then the power LED turns on, and the fan works.
- (2) Press the function conversion button on the front panel to convert the function to "GASLESS",
- (3) Adjust the welding voltage adjustment knob and wire feeding speed adjustment knob according to practical needs to get the desired welding voltage and welding current..
- (4) Press the welding torch switch, and welding can be carried out.

6.5 Single pulse gas welding

- Switch the welder to aluminum-magnesium welding and aluminum-silicon welding as shown in the figure below by using the function switch button. (Part of the aircraft)

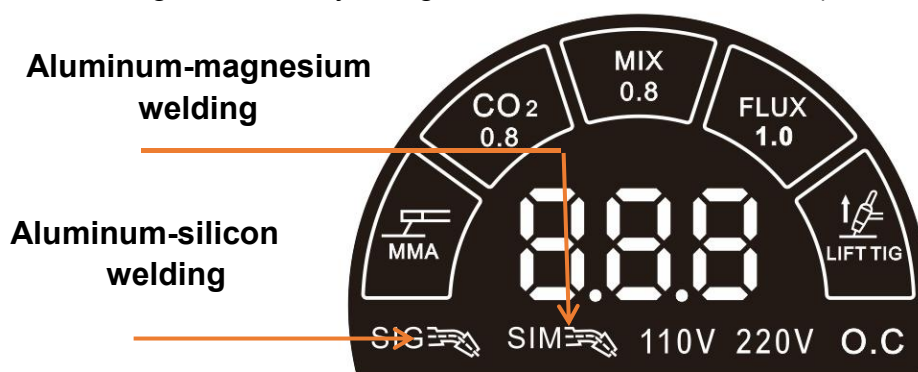

7.1 Working Environment

- (1) Welding should be carried out in a relatively dry environment with its humidity of 90% or less.
- (2) The temperature of the working environment should be within -10C to 40C.
- (3) Avoid welding in the open air unless sheltered from sunlight and rain, and never let rain or water Infilter the machine.
- (4) Avoid welding in dusty area or environment with corrosive chemical gas.
- (5) Avoid gas shielded arc welding in environment with strong airflow.

7.2 Good Ventilation

This welding machine has so big welding current when working that nature ventilation can not meet the cooling demand, while the inner fan enables the machine to work steadily by its effective cooling. Operator should make sure the louvers are uncovered and unblocked. The minimum distance between the machine and nearby objects should be 30cm. Good ventilation is of critical importance to the normal performance and service life of the machine.

7.3 No Overvoltage

If the voltage exceeds the permitted limit, the machine will be damaged, so pay attention to the changes in voltage. Once overvoltage occurs, stop welding and switch off the power.

7.4 No Overload

Remember to observe the max load current at any moment (refer to the optioned duty cycle). Make sure that the welding current should not exceed the max load current. Over-load current could obviously shorten the welding equipment's life, or even burn the equipment.

7.5 Overheating Protection

Overheating protection appears while the machine is of overload status because of continuous welding for a long time, and a sudden halt of welding occurs. In this case, it is unnecessary to restart the machine, but just wait for the overheating LED to go out, and welding can be recovered.

08

MAINTENANCE



WARNING: The following operation requires sufficient professional knowledge on electric aspect and comprehensive security knowledge. Operators should be holders of valid qualification certificates which can prove their skills and knowledge. Make sure the input cable of the machine is cut off from the electricity before uncovering the welding machine.

- 1. Check periodically whether inner circuit connection is ok (esp. plugs). Tighten the loose connection. If there is oxidization, remove it with sandpaper and then reconnect.
- 2. Keep hands, hair and tools away from the moving parts such as the fan to avoid personal injury or machine damage.
- 3. Clean the dust periodically with dry and clean compressed air. If welding in environment with heavy smoke and pollution, the machine should be cleaned daily. The pressure of compressed air should be at a proper lever lest the small parts inside the machine be damaged.
- 4. Avoid rain, water and vapor infiltrate the machine. If there is, dry it and check the insulation with a megger (including that between the connections and that between the connection and the case). Only when there is no abnormal phenomena can welding be continued.
- 5. Check periodically whether the insulation skin of all cables are perfect. If there is any dilapidation, wrap it or replace it.
- 6. Check periodically whether the gas hose has any cracks. If any, get them replaced.
- 7. Put the machine into the original packing in dry location if it is not to be used for a long time.

09

TROUBLESHOOTING



WARNING: The following operation requires sufficient professional knowledge on electric aspect and comprehensive security knowledge. Operators should be holders of valid qualification certificates which can prove their skills and knowledge. Make sure the input cable of the machine is cut off from the electricity before uncovering the welding machine.

9 Common Malfunction Analysis and Solution

Phenomena	Solution
1. The overheating LED flashes.	<ol style="list-style-type: none"> 1. Check the working current and the working time, and use the machine according to the parameters in this manual. 2. Check the running situation of the fan. If the fan doesn't work, check if there is power supply 220V: If the power supply is ok, check the fan; if the power supply is abnormal, check the power cable. 3. Replace the thermal switch if it is damaged.
2. The power LED is off, and there is no current output.	<ol style="list-style-type: none"> 1. Check if the fan works. If not, the power cable is not in good connection. 2. If the fan works, control PCB board inside the machine fails.
3. No response when pressing welding torch switch; the protection LED is off.	<ol style="list-style-type: none"> 1. Check if the welding torch switch is in good connection. 2. Check the connection condition of the welding torch and the Euro socket and check the control jack of the Euro socket. 3. Control PCB board inside the machine fails.
4. Press the welding torch switch to input gas, but no current output, and the protection LED is off.	<ol style="list-style-type: none"> 1. Check if the power cable connecting the workpiece is in good connection. 2. Check if the position where the fast socket inserting the fast plug is correct. 3. Check if the wire feeder is in good connection. 4. Check if the welding torch is damaged. 5. Control PCB board inside the machine fails.
5. Press the welding torch switch to input gas, there is current output, but the wire feeder doesn't work.	<ol style="list-style-type: none"> 1. Check if the wire feeder is blocked or damaged. 2. Check if the contact tip of the welding torch is damaged or blocked. 3. Control PCB board inside the machine fails.
6. Press the welding torch switch, welding can be carried out, but the voltage can not be adjusted.	<ol style="list-style-type: none"> 1. Check if the voltage feedback cable inside the machine is ok. 2. Control PCB board inside the machine fails.
7. Welding current is unstable.	<ol style="list-style-type: none"> 1. Check the pressure of the wire feeder pole is appropriate. 2. Check if the wire feed wheel matches the welding wire. 3. Check if the contact tip is badly abraded. If it is, replace it and tighten it. 4. Check the quality of the welding wire. 5. Check if the welding torch cable is too winding. 6. Check if the metal connection part of the fast plug is loose.

8. The weld bead is not well protected.

1. Do not remove the welding torch as soon as the welding stops. Thus the shielded gas can protect the hot weld bead.
2. Prolong the post-flow time, or contact our company.

This machine is in continuous improvement, so other parts may be different except the function and operation. Your understanding would be greatly appreciated.

